

## Transmissive Optical Sensor with Phototransistor Output

### Description

This device has a compact construction where the emitting-light sources and the detectors are located face-to-face on the same optical axis. The operating wavelength is 950 nm. The detector consists of a phototransistor.

### Applications

- Contactless optoelectronic switch, control and counter

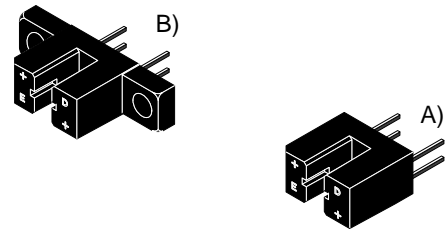

15136

### Features

- Compact construction
- No setting efforts
- Polycarbonate case protected against ambient light
- 2 case variations
- 3 different apertures
- CTR selected in groups (regarding fourth number of type designation)

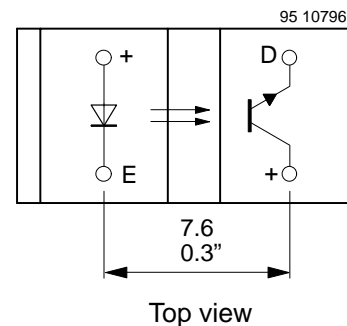

### Order Instruction

Ordering Code	Resolution (mm) / Aperture (mm)	Remarks
TCST1103 <sup>A)</sup>	0.6 / 1.0	No mounting flags
TCST2103 <sup>B)</sup>		With two mounting flags
TCST1202 <sup>A)</sup>	0.4 / 0.5	No mounting flags
TCST2202 <sup>B)</sup>		With two mounting flags
TCST1300 <sup>A)</sup>	0.2 / 0.25	No mounting flags
TCST2300 <sup>B)</sup>		With two mounting flags

### Absolute Maximum Ratings

#### Input (Emitter)

Parameter	Test Conditions	Symbol	Value	Unit
Reverse voltage		$V_R$	6	V
Forward current		$I_F$	60	mA
Forward surge current	$t_p \leq 10 \mu s$	$I_{FSM}$	3	A
Power dissipation	$T_{amb} \leq 25^\circ C$	$P_V$	100	mW
Junction temperature		$T_j$	100	$^\circ C$

#### Output (Detector)

Parameter	Test Conditions	Symbol	Value	Unit
Collector emitter voltage		$V_{CEO}$	70	V
Emitter collector voltage		$V_{ECO}$	7	V
Collector current		$I_C$	100	mA
Collector peak current	$t_p/T = 0.5, t_p \leq 10 \text{ ms}$	$I_{CM}$	200	mA
Power dissipation	$T_{amb} \leq 25^\circ C$	$P_V$	150	mW
Junction temperature		$T_j$	100	$^\circ C$

#### Coupler

Parameter	Test Conditions	Symbol	Value	Unit
Total power dissipation	$T_{amb} \leq 25^\circ C$	$P_{tot}$	250	mW
Operating temperature range		$T_{amb}$	-55 to +85	$^\circ C$
Storage temperature range		$T_{stg}$	-55 to +100	$^\circ C$
Soldering temperature	2 mm from case, $t \leq 5 \text{ s}$	$T_{sd}$	260	$^\circ C$

**Electrical Characteristics** ( $T_{amb} = 25^{\circ}\text{C}$ )**Input (Emitter)**

Parameter	Test Conditions	Symbol	Min.	Typ.	Max.	Unit
Forward voltage	$I_F = 60\text{ mA}$	$V_F$		1.25	1.6	V
Junction capacitance	$V_R = 0, f = 1\text{ MHz}$	$C_j$		50		pF

**Output (Detector)**

Parameter	Test Conditions	Symbol	Min.	Typ.	Max.	Unit
Collector emitter voltage	$I_C = 1\text{ mA}$	$V_{CEO}$	70			V
Emitter collector voltage	$I_E = 10\text{ }\mu\text{A}$	$V_{ECO}$	7			V
Collector dark current	$V_{CE} = 25\text{ V}, I_F = 0, E = 0$	$I_{CEO}$			100	nA

**Coupler**

Parameter	Test Conditions	Type	Symbol	Min.	Typ.	Max.	Unit
Current transfer ratio	$V_{CE} = 5\text{ V}, I_F = 20\text{ mA}$	TCST1103, TCST2103	CTR	10	20		%
		TCST1202, TCST2202	CTR	5	10		%
		TCST1300, TCST2300	CTR	1.25	2.5		%
Collector current	$V_{CE} = 5\text{ V}, I_F = 20\text{ mA}$	TCST1103, TCST2103	$I_C$	2	4		mA
		TCST1202, TCST2202	$I_C$	1	2		mA
		TCST1300, TCST2300	$I_C$	0.25	0.5		mA
Collector emitter saturation voltage	$I_F = 20\text{ mA}, I_C = 1\text{ mA}$	TCST1103, TCST2103	$V_{CEsat}$			0.4	V
	$I_F = 20\text{ mA}, I_C = 0.5\text{ mA}$	TCST1202, TCST2202	$V_{CEsat}$			0.4	V
	$I_F = 20\text{ mA}, I_C = 0.1\text{ mA}$	TCST1300, TCST2300	$V_{CEsat}$			0.4	V
Resolution, path of the shutter crossing the radiant sensitive zone	$I_{Crel} = 10\text{ to }90\%$	TCST1103, TCST2103	s		0.6		mm
		TCST1202, TCST2202	s		0.4		mm
		TCST1300, TCST2300	s		0.2		mm

### Switching Characteristics

Parameter	Test Conditions	Symbol	Typ.	Unit
Turn-on time	$V_S = 5\text{ V}$ , $I_C = 2\text{ mA}$ , $R_L = 100\ \Omega$ (see figure 1)	$t_{on}$	10.0	$\mu\text{s}$
Turn-off time		$t_{off}$	8.0	$\mu\text{s}$

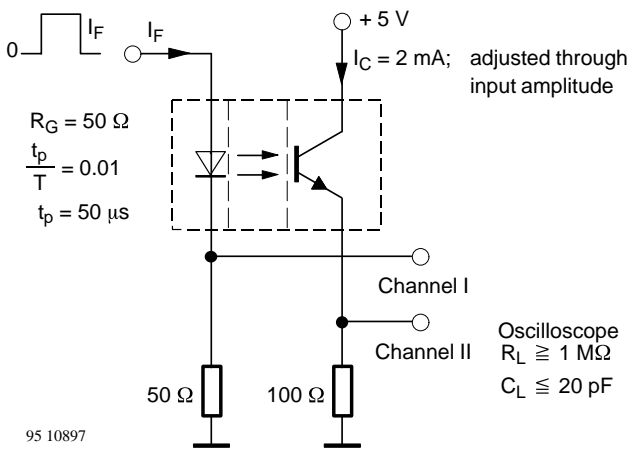
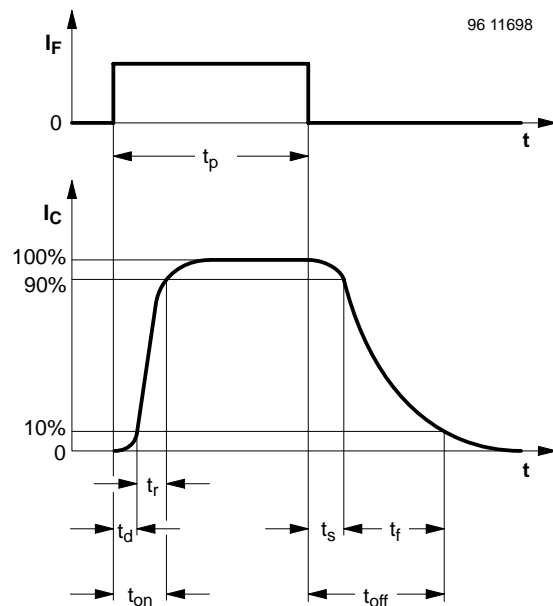

Figure 1. Test circuit, saturated operation



$t_p$	pulse duration	$t_s$	storage time
$t_d$	delay time	$t_f$	fall time
$t_r$	rise time	$t_{off} (= t_s + t_f)$	turn-off time
$t_{on} (= t_d + t_r)$	turn-on time		

Figure 2. Switching times

## Typical Characteristics ( $T_{amb} = 25^{\circ}\text{C}$ , unless otherwise specified)

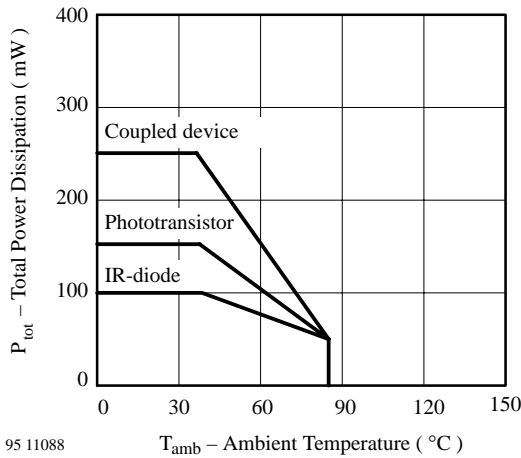

Figure 3. Total Power Dissipation vs. Ambient Temperature

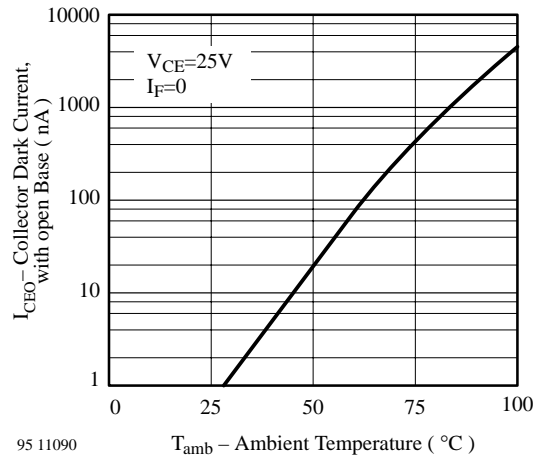

Figure 6. Collector Dark Current vs. Ambient Temperature

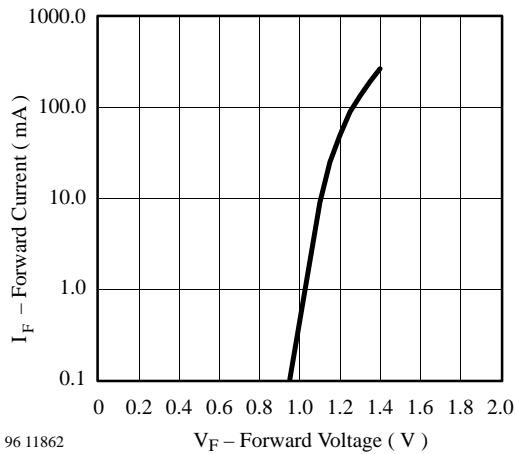

Figure 4. Forward Current vs. Forward Voltage

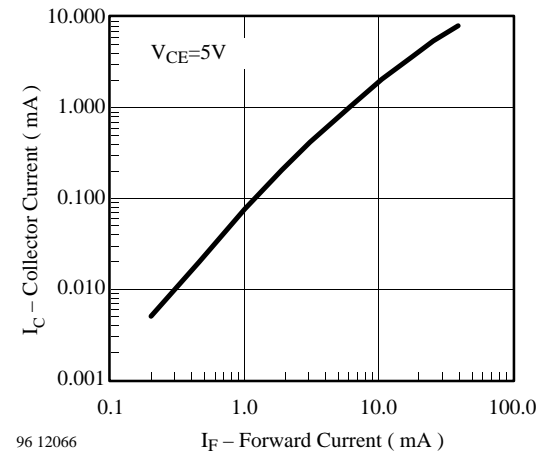

Figure 7. Collector Current vs. Forward Current

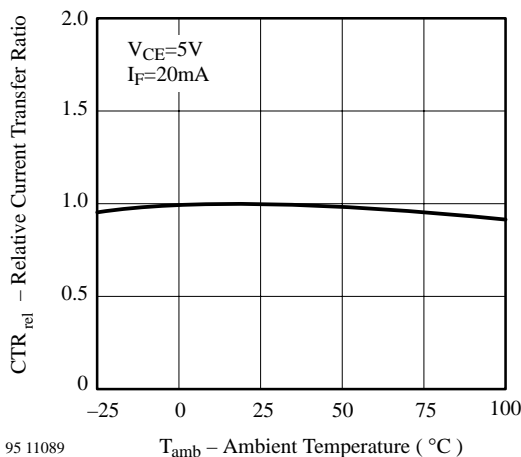

Figure 5. Relative Current Transfer Ratio vs. Ambient Temperature

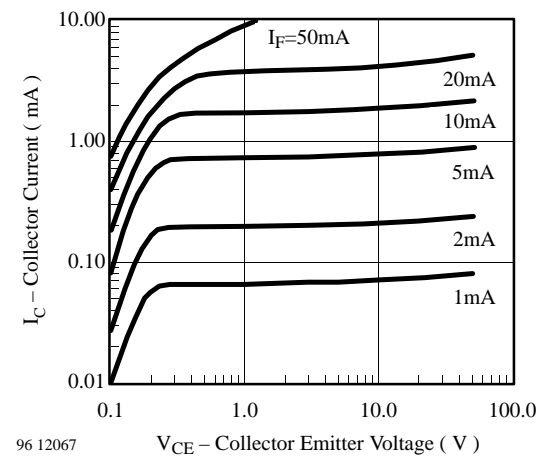

Figure 8. Collector Current vs. Collector Emitter Voltage

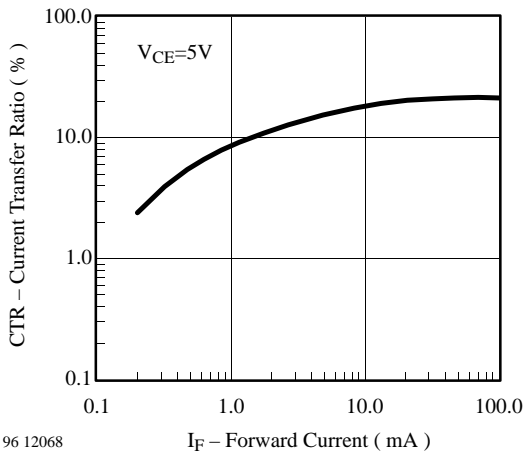

Figure 9. Current Transfer Ratio vs. Forward Current

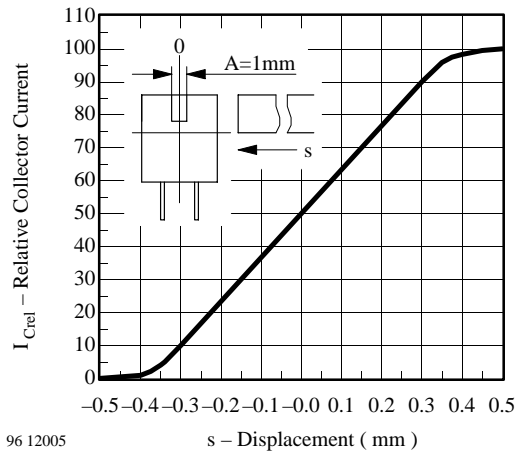

Figure 11. Relative Collector Current vs. Displacement

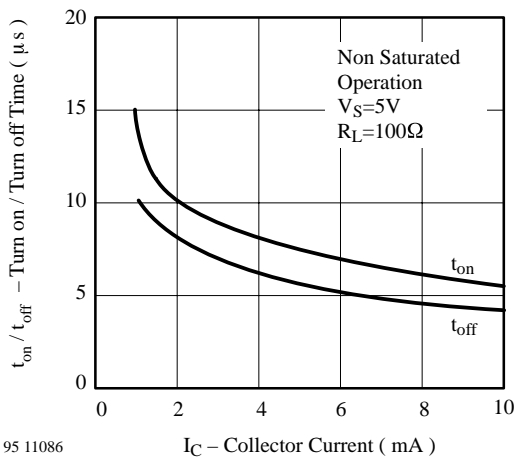

Figure 10. Turn on / off Time vs. Collector Current

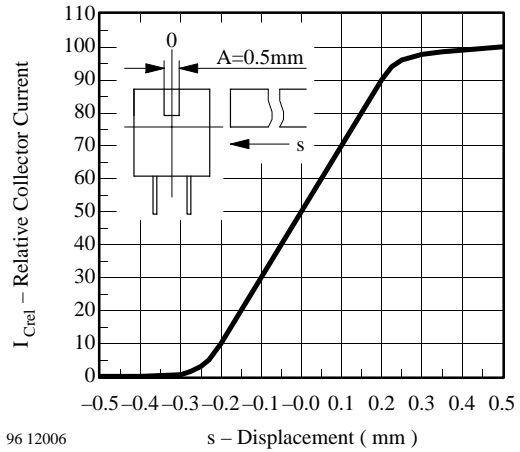

Figure 12. Relative Collector Current vs. Displacement

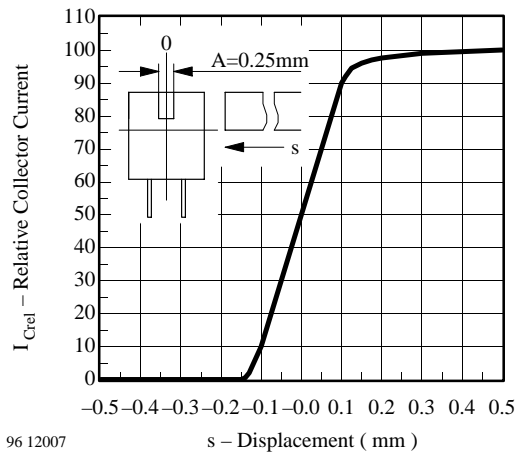
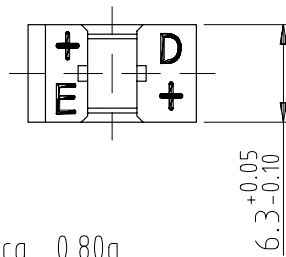
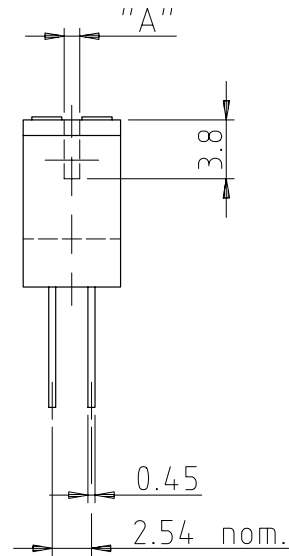
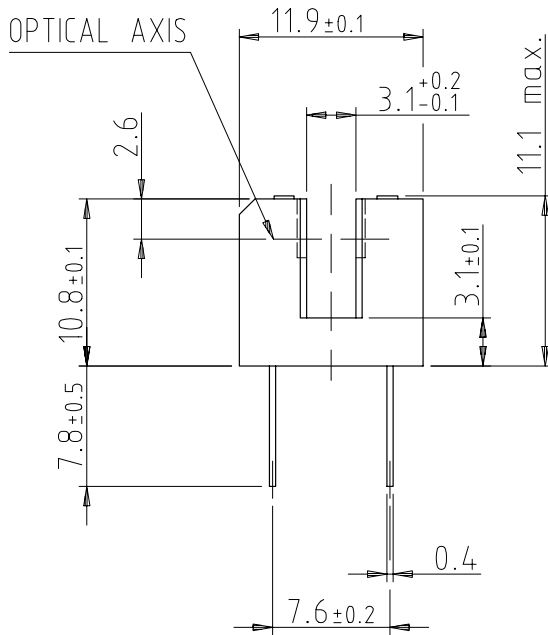

Figure 13. Relative Collector Current vs. Displacement



Dimensions of TCST1.0. in mm



weight: ca. 0.80g

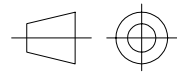

technical drawings according to DIN specifications

96 12094

# TCST110. up to TCST230.



Vishay Telefunken

## Dimensions of TCST2.0. in mm

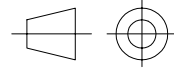
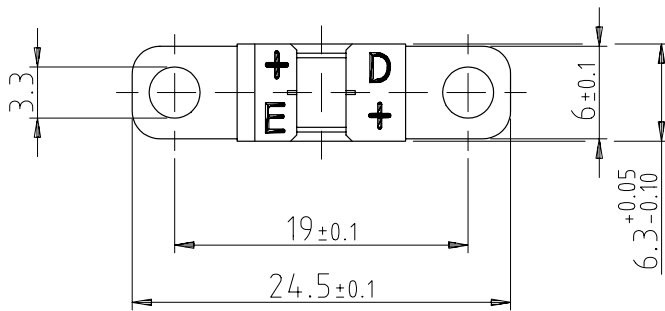
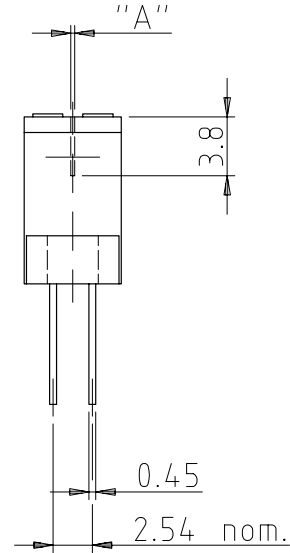
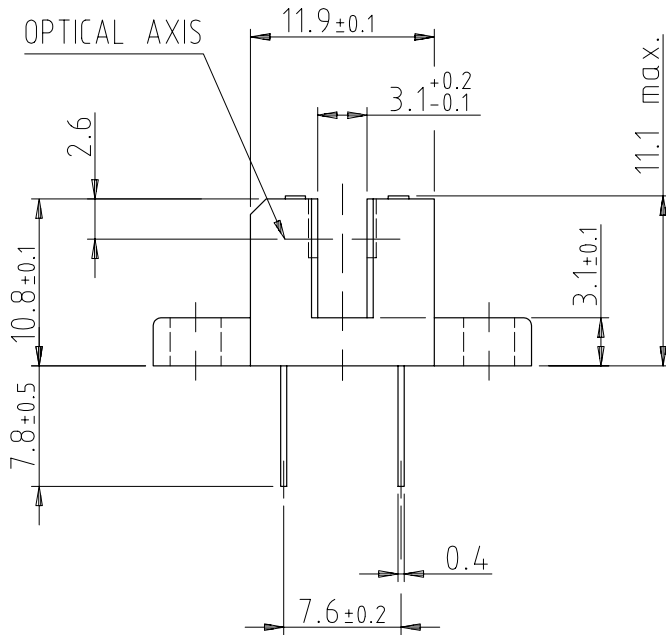

technical drawings  
according to DIN  
specifications

weight: ca. 0.90g

96 12095





## Ozone Depleting Substances Policy Statement

It is the policy of **Vishay Semiconductor GmbH** to

1. Meet all present and future national and international statutory requirements.
2. Regularly and continuously improve the performance of our products, processes, distribution and operating systems with respect to their impact on the health and safety of our employees and the public, as well as their impact on the environment.

It is particular concern to control or eliminate releases of those substances into the atmosphere which are known as ozone depleting substances (ODSs).

The Montreal Protocol (1987) and its London Amendments (1990) intend to severely restrict the use of ODSs and forbid their use within the next ten years. Various national and international initiatives are pressing for an earlier ban on these substances.

**Vishay Semiconductor GmbH** has been able to use its policy of continuous improvements to eliminate the use of ODSs listed in the following documents.

1. Annex A, B and list of transitional substances of the Montreal Protocol and the London Amendments respectively
2. Class I and II ozone depleting substances in the Clean Air Act Amendments of 1990 by the Environmental Protection Agency (EPA) in the USA
3. Council Decision 88/540/EEC and 91/690/EEC Annex A, B and C (transitional substances) respectively.

**Vishay Semiconductor GmbH** can certify that our semiconductors are not manufactured with ozone depleting substances and do not contain such substances.

**We reserve the right to make changes to improve technical design and may do so without further notice.**

Parameters can vary in different applications. All operating parameters must be validated for each customer application by the customer. Should the buyer use Vishay Telefunken products for any unintended or unauthorized application, the buyer shall indemnify Vishay Telefunken against all claims, costs, damages, and expenses, arising out of, directly or indirectly, any claim of personal damage, injury or death associated with such unintended or unauthorized use.

Vishay Semiconductor GmbH, P.O.B. 3535, D-74025 Heilbronn, Germany  
Telephone: 49 (0) 7131 67 2831, Fax number: 49 (0) 7131 67 2423

Find price and stock options from leading distributors for TCST1103 on Findchips.com:

<https://findchips.com/search/TCST1103>

Find CAD models and details for this part:

<https://findchips.com/detail/tcst1103/Vishay-Intertechnologies>